

CK3000 EVOLUTION and MK6000 CONNECTION DIGRAM

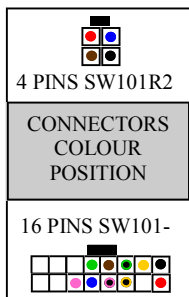

HARNESS CABLE COLOURS

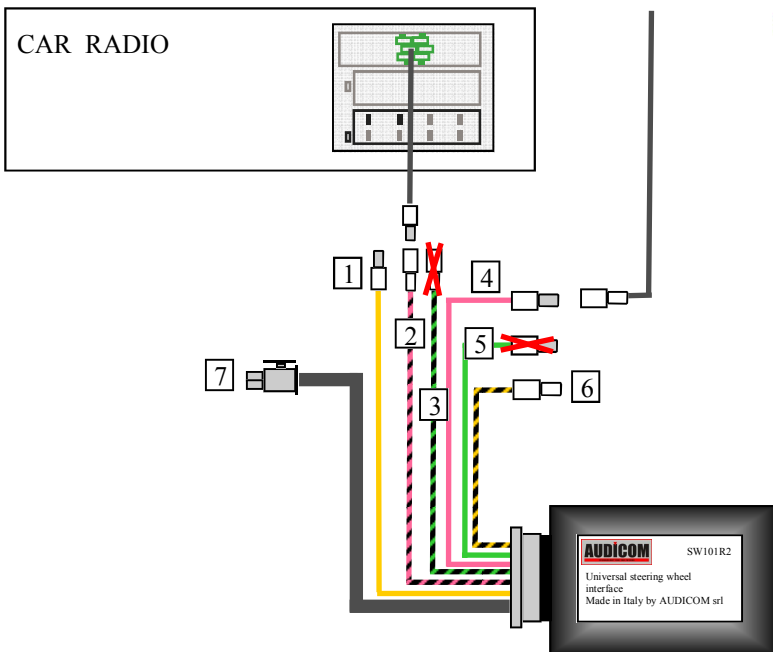

- 1 YELLOW= Connect to **MUTE 2** of the car kit's grey connector
- 2 PINK/BLACK = connect to the BUS wire of car radio
- 3 GREEN/BLACK= **NOT TO CONNECT**
- 4 PINK = Connect to BUS wire to the car
- 5 GREEN = **NOT TO CONNECT**
- 6 YELLOW/BLACK Connect to **MUTE** of the car kit (yellow with red connector)
- 7 To the PARROT ck 3000 evolution / mk6000 car kit

SWITCHES PROGRAM WITH RADIO "FUJITSU"

SWITCHES PROGRAM WITH RADIO "BLAUPUNKT"

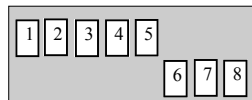

CK3000 evo

MK6000

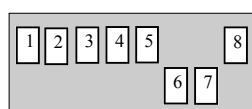
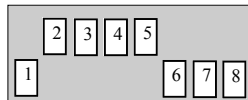

CK3000 evo

MK6000

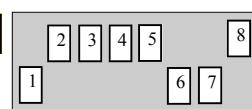

DEDICATED HARNESS FOR PLUG'N "PLAY INSTALLATION

CP096M

PLUG & PLAY HARNES FOR CAR5 WITH **BLAUPUNKT** RADIO

CP095M

PLUG & PLAY HARNES FOR CAR5 WITH **FUJITSU** RADIO

**INSTALLATION "PIN TO PIN" CHEVROLET
WITH CAR RADIO "BLAUPUNKT"
DEDICATED HARNESS
(CP096M)**

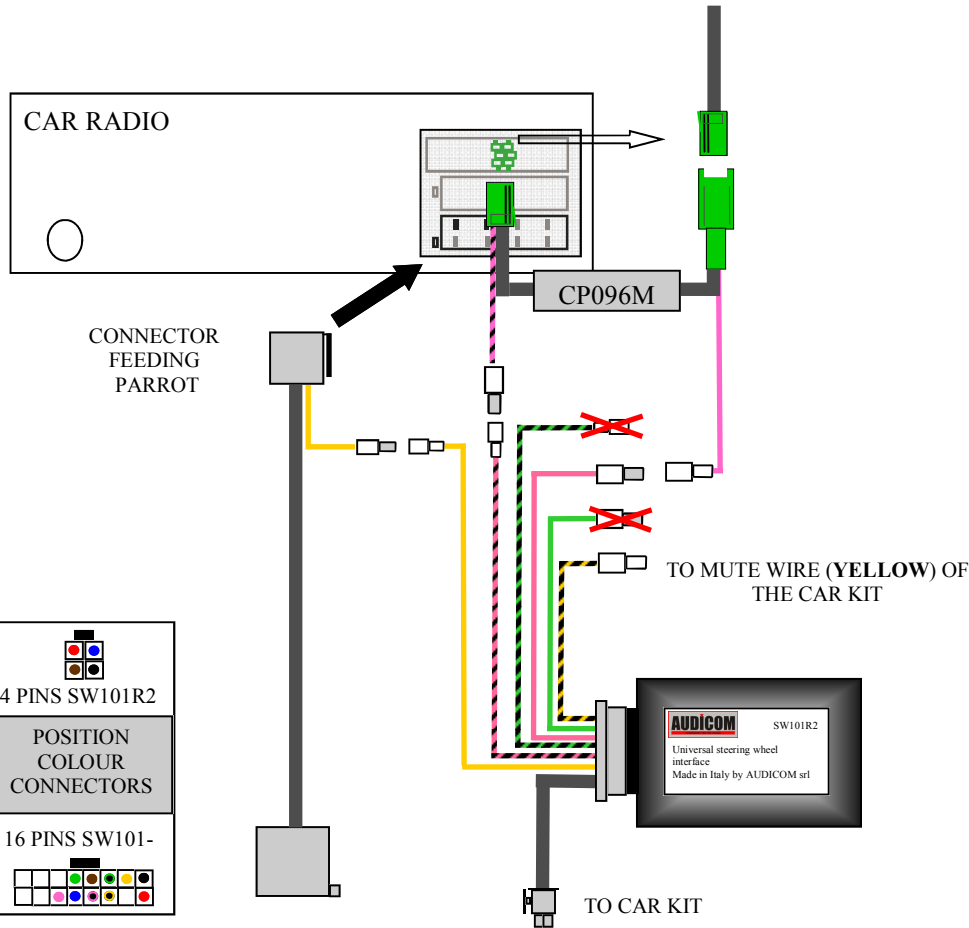

TECHNICAL NOTES

Extract from the connector of the car radio, the connector miniiso's GREEN part and connect it to the female of the harness CP196M; connect then the male connector of CP096M into green miniso connector into car radio.
Connect the MUTE2 wire(YELLOW) of Parrot's GREY connector to the YELLOW wire of SW101R2 interface.
This type of BUS is monophyletic: connect then only PINK/BLACK wire to the radio and the PINK to the equipment.
Do not connect the GREEN and the GREEN/BLACK wire.

**INSTALLATION "PIN TO PIN" CHEVROLET
WITH CAR RADIO "FUJITSU"
DEDICATED HARNESS
(CP095M)**

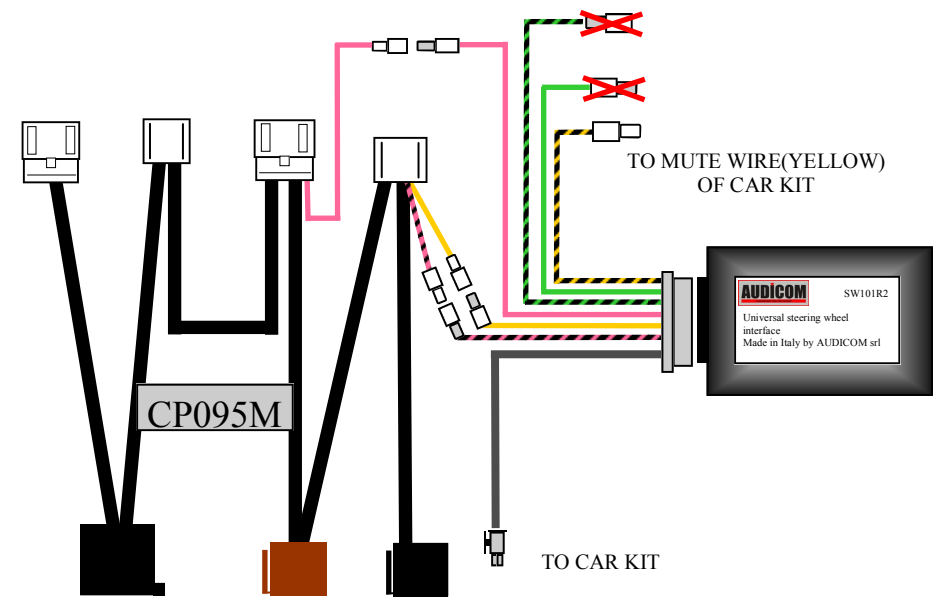

NOTES

Connector CP095 is dedicated for Fujitsu car radio, installed normally on CAPTIVA model. Also in this case, the BUS line is monophyletic and so is not necessary to connect the GREEN and GREEN/BLACK bus wire coming out from SW101R2 control unit.